

# Teensy<sup>®</sup> 3.6 Back Side

Additional pins and features available on the back side

Cut to separate VIN from VUSB, if using a battery charger or external power.

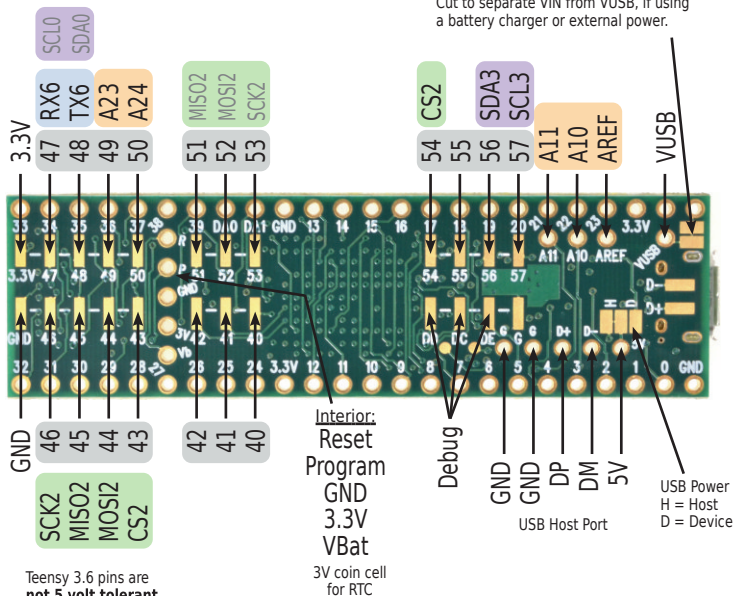

Teensy 3.6 pins are **not 5 volt tolerant**. Do not apply more than 3.3 volts.

For solutions to the most common issues and technical support, please visit:

[www.pjrc.com/help](http://www.pjrc.com/help)

Teensy 3.6 System Requirements:

PC computer with Windows 7, 8, 10 or later

or Ubuntu Linux 14.04 or later

or Macintosh OS-X 10.8 or later

USB Micro-B Cable

